

## 3.9 Installation

### 3.9.1 Safety

- If the air conditioner is transferred to a new user, this manual shall be transferred to the user, together with the conditioner.
- Before installation, be sure to read Safety Considerations in this manual for proper installation.
- The safety considerations stated below is divided into "⚠WARNING" and "⚠ATTENTION". The matters on severe accidents caused from wrong installation, which is likely to lead to death or serious injury, are listed in "⚠WARNING". However, the matters listed in "⚠ATTENTION" are also likely cause the severe accidents. In general, both of them are the important items related to the security, which should be strictly abided by.
- After the installation, perform test run to make sure everything is in normal conditions, and then operate and maintain the air conditioner in accordance with the User Manual. The User Manual should be delivered to the user for proper keeping.

### **WARNING**

- Please ask the special maintenance station for installation and repair. Water leakage, electric shocks or fire accidents might be caused from improper installation if you conduct the installation by your own.
- The installation should be conducted properly according to this manual. Water leakage, electric shocks or fire accidents might be caused from improper installation.
- Please make sure to install the air conditioner on the place where can bear the weight of the air conditioner. The air conditioner can't be installed on the grids such as the non-special metal burglar-proof net. The place with insufficient support strength might cause the dropdown of the machine, which may lead to personal injuries.
- The installation should be ensured against typhoons and earthquakes, etc. The installation uncomformable to the requirements will lead to accidents due to the turnover of the machine.
- Specific cables should be used for reliable connections of the wirings. Please fix the terminal connections reliably to avoid the outside force applied on the cables from being impressed on the cables. Improper connections and fixings might lead to such accidents as heating or fire accidents.
- Correct shapes of wirings should be kept while the embossed shape is not allowed. The wirings should be reliably connected to avoid the cover and the plate of the electrical cabinet lipping the wiring. Improper installation might cause such accidents as heating or fire accidents.
- While placing or reinstalling the air conditioner, except the specific refrigerant (R410A), don't let the air go into the refrigeration cycle system. The air in the refrigeration cycle system might lead to the cracking or personal injuries due to abnormal high pressure of the refrigeration cycle system.
- During installation, please use the accompanied spare parts or specific parts. If not, water leakage, electric shocks, fire accidents or refrigerant leakage might be caused.
- Don't drain the water from the drainpipe to the waterspout where may exist harmful gases such as sulfureted gas to avoid the harmful gases entering into the room.
- During installation, if refrigerant leakage occurs, ventilation measures should be taken, for the refrigerant gas might generate harmful gases upon contacting the flame.
- After installation, check if any refrigerant leakage exists. If the refrigerant gas leaks in the room, such things as air blowing heaters and stoves, etc. may generate harmful gases.
- Don't install the air conditioner at the places where the flammable gases may leak. In case the gas leakage occurs around the machine, such accidents as fire disasters may be caused.
- The drainpipe should be properly mounted according to this manual as to ensure the smooth drainage. In addition, heat preservation should be taken to avoid condensation. Improper drainpipe mounting might cause water leakage, which will get the articles at home wet.
- The refrigerant gas pipe and liquid pipe should be heat insulated to preserve heat. For inappropriate heat insulation, the water caused from the condensation will drop to get the article at home wet.
- If the supply cord is damaged, it must be replaced by the manufacturer, its service agent or similarly qualified persons in order to avoid a hazard.
- This appliance is not intended for use by persons (including children) with reduced physical, sensory or mental capabilities, or lack of experience and knowledge, unless they have been given supervision or instruction concerning use of the appliance by a person responsible for their safety.
- Children should be supervised to ensure that they do not play with the appliance.

















- This appliance can be used by children aged from 8 years and above and persons with reduced physical, sensory or mental capabilities or lack of experience and knowledge if they have been given supervision or instruction concerning use of the appliance in a safe way and understand the hazards involved. Children shall not play with the appliance. Cleaning and user maintenance shall not be made by children without supervision.
- The appliances are not intended to be operated by means of an external timer or separate remote-control system.
- Keep the appliance and its cord out of reach of children less than 8 years.

## ⚠ CAUTION

- The air conditioner should be effectively grounded. Electric shocks may occur if the air conditioner is ungrounded or inappropriately grounded. The wire for earthing shouldn't be connected to the connections on the gas pipe, water pipe, lightning rod or telephone.
- The breaker for electricity leakage should be mounted. If not, accidents such as electric shocks may happen.
- The installed air conditioner should be checked for electricity leakage by being powered.
- If the ambient humidity bigger than 80%, when the water discharge hole be blocked or the filter becomes dirty, or airflow speed change, there maybe leads to condensing water drop down, and at the same time there maybe some drops of water spit out.

## ⚠ ATTENTION

**Notices during operation**

- |  |  |
|--|--|
| <ul style="list-style-type: none"> <li>■ It is not allowed to put any heating apparatus under the indoor units, for the heat may cause distortion of the units.</li> <li>■ Pay attention to the aeration condition to avoid anoxic symptom. </li> <li>■ Flammable apparatus should not be placed in the place where the air conditioner wind could reach directly, or incomplete burning of the apparatus may be caused. </li> <li>■ Check the mount table of the air conditioner for damage for a long period of operation.  If placed on the damaged table, the unit may drop down causing damage. </li> <li>■ Plants and animals should not be put to the place where wind of the air conditioner blows directly, otherwise damage to them may be caused. </li> <li>■ It cannot be used for the preservation of food, living creature, precise instrument and artworks, etc, otherwise damage may occur. </li> <li>■ Use the fuse with proper capacity. Metal wires and copper wires, etc., may cause fire or other faults. </li> <li>■ Do not use water heater or like next to the indoor unit and the wired controller. Water/power leakage or short circuit may happen if the steam generating apparatus is working next to machine. </li> <li>■ Defrosting during heating<br/>To improve the heating effect, the outdoor unit will perform defrosting automatically when frost appears on the outdoor unit during heating (approximately 2-10 min). During defrosting, the fan of the indoor unit runs at a low speed or stops while that of the outdoor unit stops running. </li> <li>■ Do not touch the switch with the wet hand to avoid power shock. </li> </ul> | <ul style="list-style-type: none"> <li>■ Power should be cut off when the air conditioner is left unused for a long period. Power will be consumed if the air conditioner is not powered off. The power switch of the outdoor unit switch should be powered on 12 hours in advance before operation to protect the unit after a long period of storage.</li> <li>■ 3-minute protection<br/>To protect the unit, compressor can be actuated with at least 3-minute delay after stopping.</li> <li>■ Close the window to avoid outdoor air getting in. Curtains or window shutters can be put down to avoid the sunshine. </li> <li>■ Stop running and switch off the manual power switch when cleaning the unit. </li> <li>■ During the operation of the control unit, don't switch off the manual power switch and the controller can be used. Please do not press the liquid crystal zone of controller to prevent damage. </li> <li>■ Cleaning the unit with water may cause electric shock. </li> <li>■ Do not put flammable spray close to the air conditioner. Don't inject flammable spray towards the air conditioner, which may cause fire.   </li> <li>■ Stopping fan rotation<br/>The unit which stops operating will actuate the fan for a 2-8 min swing every 30-60 minutes for protecting the unit while other indoor unit are in the operating state.</li> <li>■ This appliance is not intended for use by persons (including children) with reduced physical, sensory or mental capabilities, or lack of experience and knowledge, unless they have been given supervision or instruction concerning use of the appliance by a person responsible for their safety.</li> </ul> |
|--|--|

## 3.9.2 Maintenance

### ⚠ ATTENTION

- Repair can only be performed by professional personnel.
- Before touching the connection line, all power supplies should be switched off. Only after switching off the power supply can the operator clean the air conditioner as to avoid electric shock or injury.
- When cleaning the air cleaner, make sure to use a stable platform; don't flush the air conditioner with water, or the electric shock might be caused.

### Daily Maintenance:

Clean the air cleaner & air inlet grid.

- Don't dismantle the air cleaner if not cleaning, or faults might be caused.
  - When the air conditioner operates in the environment with too much dust, clean the air conditioner more times (generally once every two weeks).
1. Remove the air inlet grid as shown in the figure: press down the two locks on the grid (as shown in Fig. 1) to move it close to the nearby grid, gently lift it 45 degree (as shown in Fig. 2), and then remove the air inlet grid.
  2. Dismantle the gauze: press the outer frame of the air inlet grid by the thumb, and draw the base angle of gauze by the forefinger and pull it out as to make the gauze disengage the locks, and dismantle the gauze (as shown in Fig. 3).

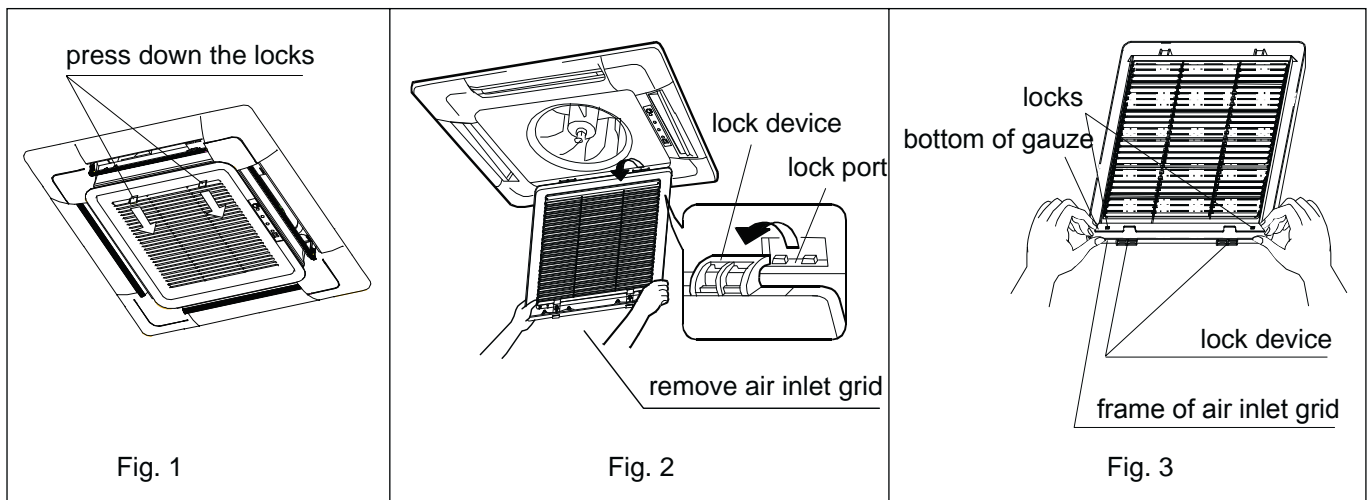

### Cleaning Air Cleaner

#### ■ Cleaning

Clean the air cleaner with the dust collector or water to remove dusts.

For too much dust, use the fan or directly spray the special cookware detergent on the air inlet grid, and then clean it with water after 10 minutes.

(A) Remove dust with dust collector.

(B) For too much dust, use soft-hair brush and mild detergent to clean.

(C) Throw off water and then dry it at cool places.

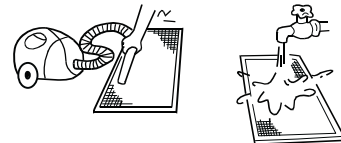

### ⚠ ATTENTION

- Don't clean it with hot water of over 50°C to avoid fading or distortion.
- Don't dry it on the fire, or the cleaner might cause fire.

## Installing air cleaner and air inlet grid:

1. Mounting the gauze: opposite to the ways of dismantling the gauze (as shown in Fig. 3 above).
2. Mounting the air inlet grid: as shown in the right figure, nip the locks on the grid as directed by arrows, put the side with the lock device into the lock port, and then put the side with locks into the panel frame. Release the locks to position the grid after determining that the grid is abutting upon the bottom of the panel frame.

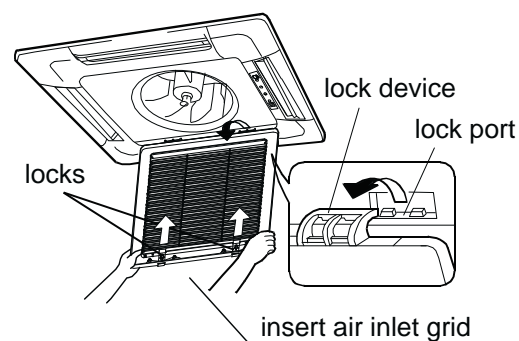

### ATTENTION

#### Cleaning the air outlet port and the shell:

- Don't use gasoline, benzene, diluents, polishing powder or liquid insecticide to clean them.
- Do not clean them with hot water of above 50°C to avoid fading or distorting.
- Wipe them with soft dry cloth.
- Water or neutral dry cleanser is recommended if the dust cannot be removed.
- The Wind Deflector can be dismantled to clean (as below).

#### Cleaning Wind Deflector:

- Do not wipe the wind deflector with water forcibly to avoid the floss falling off.

## Maintenance before and after Operating Season

### Before Operating Season:

1. Please make the following checkup:
  - There is no blockage in inlet port and outlet port of outdoor and indoor units.
  - The ground line and the wiring are in the proper state.  
If abnormal condition occurs, consult the after-service personnel.
2. Clean the air cleaner and the shell.
  - After cleaning, the air cleaner must be mounted.
3. Switch it on to the power.
  - After cleaning, the air cleaner must be mounted.

### After Operating Season:

1. In sunny days, blowing operation can be performed for half a day to make the inside of machine dry.
2. Switch it off.
  - Electrical power should be cut down to economize electricity, or the machine will still consume power.
3. Clean the air cleaner and the shell.
  - Air cleaner and shell must be mounted after cleaning. For cleaning details, refer to Maintenance.

### 3.9.3 Fault checkup

Please check the following when consigning repair service:

	Symptoms	Reasons
All these are not problems	Water flow sound	Water flow sound can be heard when starting operation, during operation or immediately after stopping operation. When it starts to work for 2-3 minutes, the sound may become louder, which is the flowing sound of refrigerant or the draining sound of condensed water.
	Cracking sound	During operation, the air conditioner may make the cracking sound, which is caused from the temperature changes or the slight dilation of heat exchanger.
	Terrible smell in outlet air	The terrible smell, caused from walls, carpet, furniture, clothing, cigarette and cosmetics, attaches on the conditioner.
	Flashing operating indicator	When switching it on again after power failure, turn on the manual power switch and the operating indicator flashes.
	Awaiting indication	It displays the awaiting indication as it fails to perform refrigerating operation while other indoor units are in heating operation. When the operator set it to the refrigerating or heating mode and the operation is opposite to the setting, it displays the awaiting indication.
	Sound in shutdown indoor unit or white steam or cold air	To prevent oil and refrigerant from blocking the shutdown indoor units, refrigerant flows in the short time and make the sounds of refrigerant flowing. Otherwise, when other indoor units perform heating operation, white steam may occur; during refrigerating operation, cold air may appear.
	Clicking sound when switching the air condition on	When the conditioner is powered on, the sound is made due to the resetting of the expansion valve.
	Please make another check	Start or stop working automatically
Failure to work 		Check if there is a power failure. Check if the manual power switch is turned off. Check if the supply fuse and breaker are disconnected. Check if the protective unit is working. Check if refrigerating and heating functions are selected simultaneously with the awaiting indication on line control.
Bad cooling & heating effects		Check if air intake port and air outlet port of outdoor units are blocked. Check if the door and windows are open. Check if the filtering screen of air cleaner is blocked with sludge or dust. Check if the setting of wind quantity is at low wind. Check if the setting of operation is at the Fan Operation state. Check if the temperature setting is proper.

Under the following circumstances, immediately stop the operation, disconnect the manual supply switch and contact the after-service personnel.

- When buttons are inflexible actuated;
- When fuse and breaker have been burnt over and over;
- When there are foreign objects and water in the refrigerator;
- When it cannot still be operated after removing the operation of protective unit;
- When other abnormal conditions occur.

### 3.9.4 Installation procedures

The standard attached accessories of the units of this series refer to the packing list; prepare other accessories according to the requirements of the local installation point of our company. Indoor units should be installed in places with the environment of even circulation of cool and warm blows. The following places should be avoided.

- Places with high salinity (beach), high sulfured gas (such as the thermal spring regions where copper tubes and soft soldering are easy to be eroded), much oil (including mechanical oil) and steam; places where organic substance solvent is used; where special spray is frequently used;
- Places where machines generate the high frequency electromagnetic wave (abnormal condition will appear in the control system);
- Places where there is high humidity exists near the door or windows (dew is easily formed).

## ⚠ WARNING

protect the machine from gales or earthquake, make the installation according to the regulations. Improper installation will cause accidents due to the overturn of the air conditioner.

### 1. Select the following places to install indoor units

- (1) Where there is enough room for the machine above the ceiling;
- (2) Where the drainpipes can be well arranged;
- (3) Where the distance between the air outlet port of the machine and the floor is not more than 2.7m;
- (4) Where air inlet & outlet of the indoor units are not blocked;
- (5) Where it is hard enough to bear the weight of the unit;
- (6) Where there is no television, piano and other valuables under the indoor units as to avoid condensate dropping down, causing damage.
- (7) Where it is over 1m away from the television and radio as to avoid the disturbance from television and radio.

#### Installation Space

Ensure the required space for installation and maintenance (refer to the following drawings).

The installation height should be kept within 2.7m.

When the height of the ceiling exceeds 2.7m, the warm air is hard to blow to the ground.

Space required for installation (unit: mm)

Model	H
AB072~182MRERA	206
AB242~282MRERA	227
AB302~382MRERA	269
AB482~602MRERA	311



## 2. Location Relationship Among Ceiling Hole, Unit and Hoisting Studs

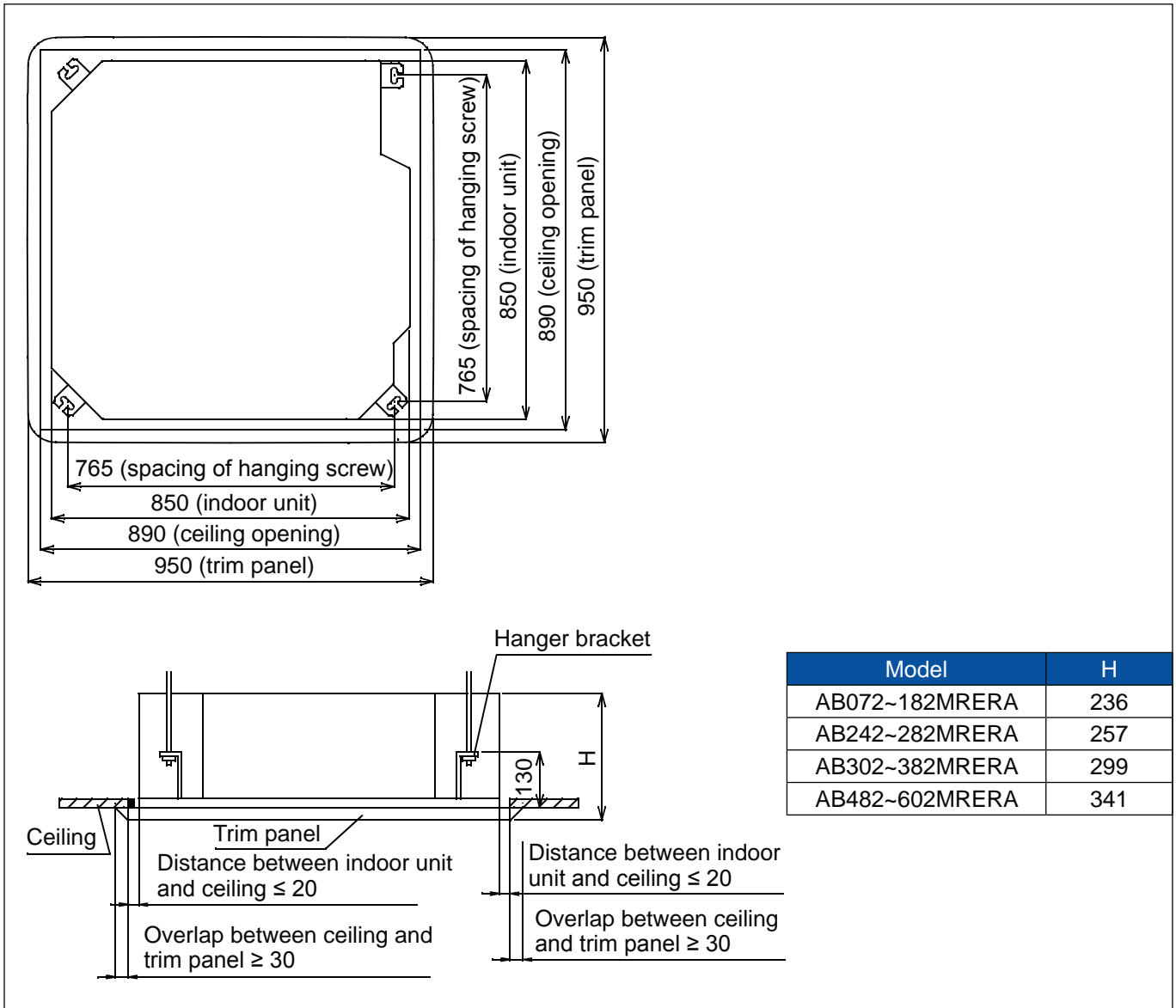

### Note:

Before suspending the indoor unit, select the installation location according to the piping and wiring in the ceiling, and determine the lead direction of the piping. Prepare all pipes (refrigerator and drainage) and wiring (connection line for remote control and connection line of indoor units and outdoor units) connected to indoor units before suspending the indoor unit so as to make the connections right after the installation.

- In the situation with the ceiling, before suspending the unit, set refrigerant pipe, drainpipe, connection line in the room, lead wire of line control to the locations of piping and wiring.
- Confirm the size of the indoor unit and fix it according to the requirements in the manual.

## 3. Ceiling Hole & Reinforcement

- (1) Cut and withdraw the foundation of ceiling according to the size of indoor unit.
- (2) After cutting an appropriate hole, reinforce the cutting area on the foundation of indoor unit, and append the rim to the ceiling to secure its foundation. In order to prevent the ceiling from vibrating, it is vital to reinforce the ceiling foundation and ensure the original levelness of the ceiling.

## 4. Hoisting Stud Installation

- To support the weight of the unit, use barb bolts in the situation with the ceiling. In the situation with the new ceiling, use inlaid bolts, embedded bolts or other parts provided on site. Before proceeding the installation, adjust the gap between the bolts and the ceiling.
- Use four M10 hoisting studs (provided on site) (when the height of the hoisting stud exceeds 0.9m, M10 studs should be used.). The gaps should be kept according to the overall drawing of the air conditioner. Make the installation according to regulations for various building structures as to ensure the safety. Use the level meter to perform the parallel installation.

### Ceiling Suspending

#### Situation with New Ceiling

- (1) Install the indoor unit temporarily:  
Attach the hoisting foot to hoisting stud. Make sure that nuts and washers should be used at two ends of the foot to secure the foot.
- (2) For the size of the ceiling hole, please refer to the schematic drawing at the previous page.  
<After finishing the installation of the ceiling>
- (3) Adjust the unit to the proper installation location.
- (4) Check if the unit is in the horizontal level:  
The indoor unit is equipped with a built-in drainage pump and a floater switch. Check if the 4 angles of the unit are in the horizontal level with the water level or the polythene tube with water, as shown in the figure, taking only one indoor unit as an example. If the unit inclines opposite to the direction of condensate flow, the floater switch might have faults, causing water dropping.
- (5) Tighten the nut on the washer.

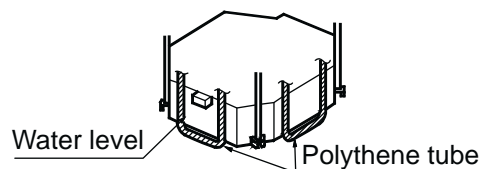

#### Situation with Original Ceiling

- (1) Install the indoor unit temporarily: attach the hoisting foot to hoisting stud. Make sure that nuts and washers (provided on site) should be used at two ends of the foot to secure the foot.
- (2) Adjust the height and location of the unit.
- (3) Perform Step 4 and 5 in Situation with New Ceiling.

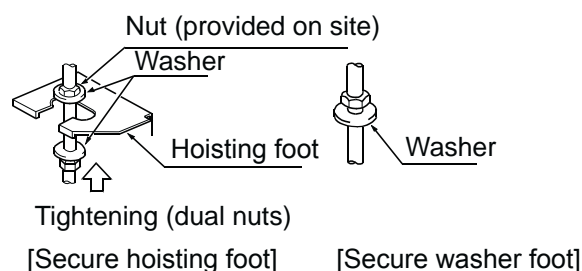

### Preparation of Decorated Board

- Don't put the decorated board downward to the floor. Putting it against the wall or on the extrusive objects is not allowed.
- Don't touch the wind deflector or apply force on it, or the wind deflector will have faults.



## Installation

### (1) Confirming the position of unit hanger

Please confirm the installation position of the hanger for indoor unit is about 130mm above the ceiling. For details, please refer to the Instructions for Installation and Maintenance of indoor unit.

### (2) Removing the air-inlet grille

Open the air-inlet grille to make it at an angle of 45° to the trim panel. As shown in the following figure, please remove the air-inlet grille as per the operation requirements.

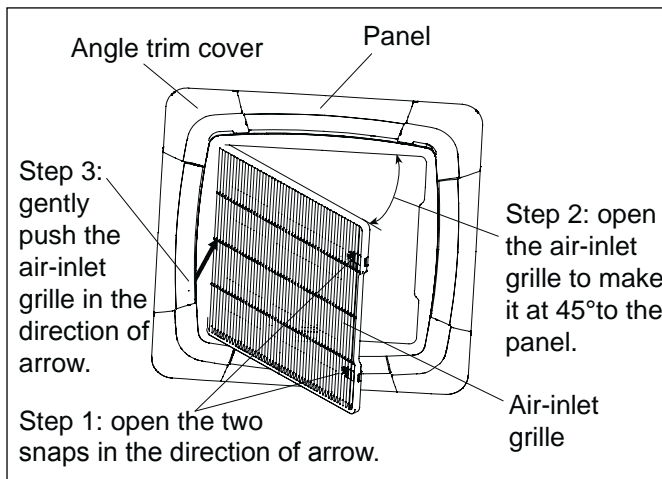

### (3) Installing the panel

1) Please remove the four (4) angle trim panels. Removal method: Flip the jack catches of the angle trim panel in the order of ①②③④, as shown in the following figure. The flipping direction is indicated by the arrows. Then the angle trim panel can be removed.

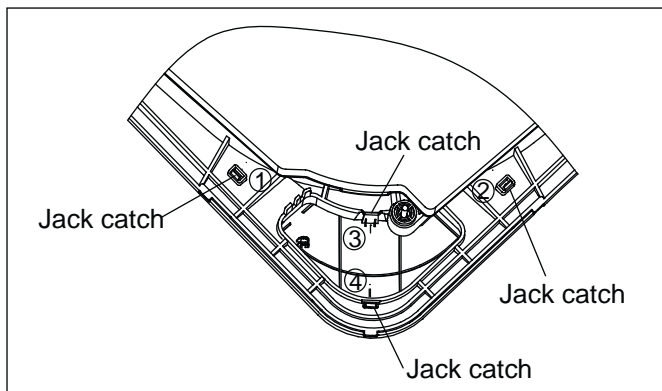

2) Pull out the two (2) U-shaped hooks on the indoor unit from below.

3) Adjust the panel direction to make the angle side engraved with "Pipe side" consistent with the refrigerant pipe of the indoor unit, and make the angle side engraved with "Drain side" consistent with the drain side of the indoor unit. Then hang the 2 hooks in the inner side of the panel on the 2 U-shaped hooks of the indoor unit.

4) Finally fix the panel on the indoor unit with the bolts (M5\*25) and gaskets delivered with the unit.

Caution: gaskets must be used for fixing, or else the panel would be easy to fall off.

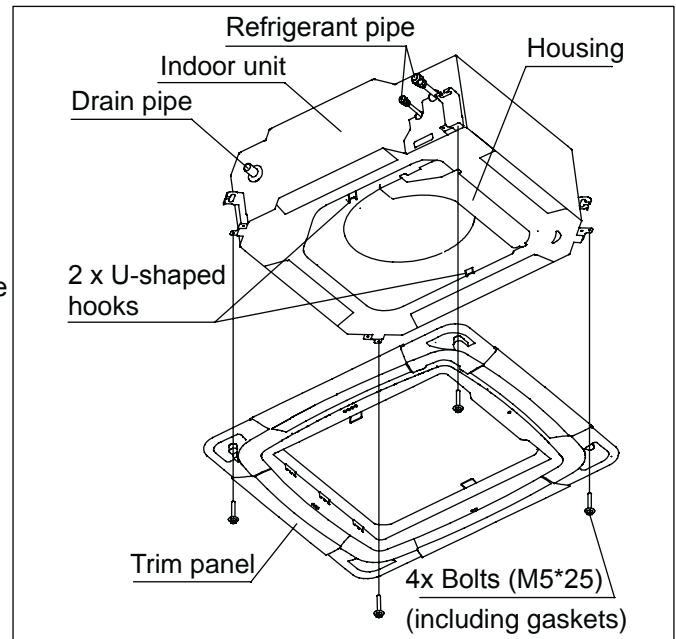

5) When tightening the four (4) bolts, please make sure there is no clearance between the panel fixing seat on the side of the indoor unit and the panel fixing seat on the side of the panel. That is to say: the bolts shall be fully tightened (see \* in the figure).

If there is a clearance, air leakage or water leakage is likely to occur.

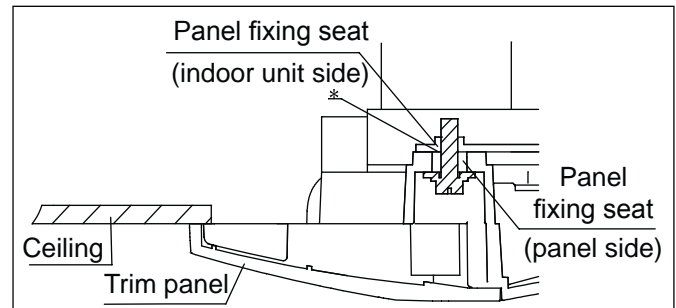

### Caution:

■ Improper tightening of bolts would lead to the faults shown in the following figure.

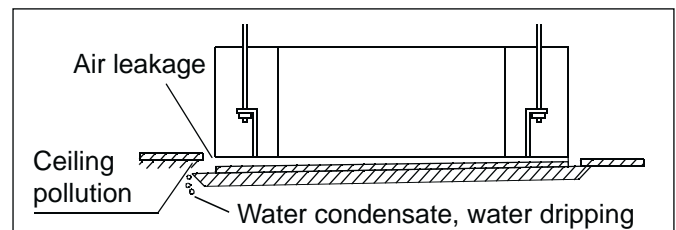

■ After tightening the bolts, if there is a clearance between the ceiling and the trim panel, please readjust the height of the indoor unit.

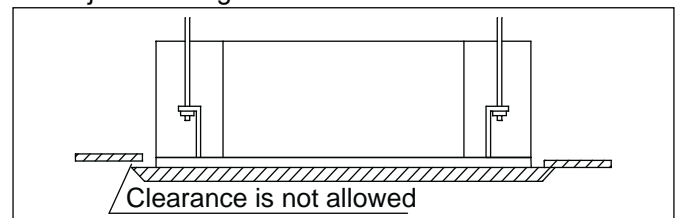

If the elevation level of the indoor unit and drain pipe are not affected, you can adjust the height of the indoor unit through the corner pore on the trim panel. Please keep the unit horizontal in the process of adjustment, or else water leakage is easy to occur.

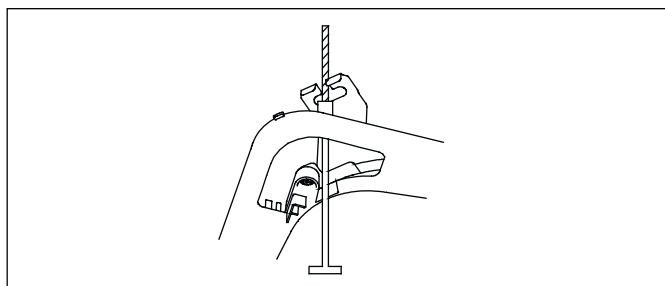

- Please do not swing the louver blade by hand, or else the blade mechanism would be damaged.

6) Connection of trim panel. Connect the black lead-out terminal of the panel to the black lead-out terminal of the indoor unit housing.

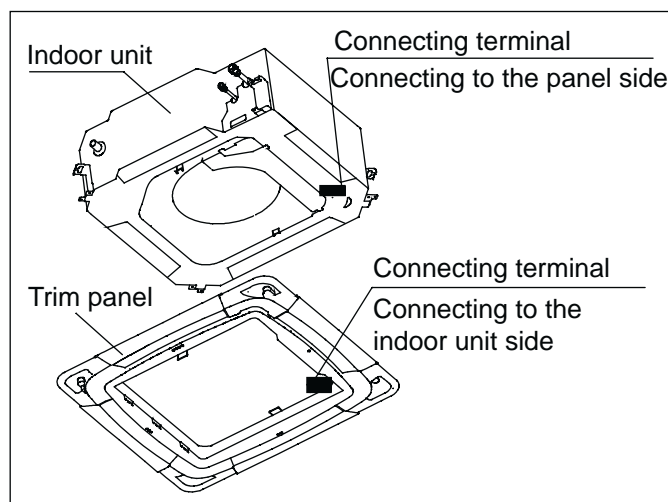

7) When the installation of panel is complete, please fix the four (4) angle trim panels.

- Hang and tighten the strap of the angle trim panel on the shackle of the trim panel, as shown in the figure.
- Fix the angle trim panel on the trim panel.

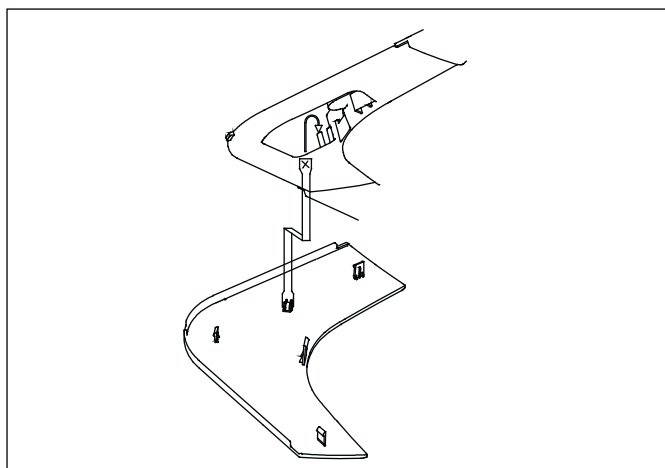

8) Installing the air-inlet grille.

Install the air-inlet grille with the steps opposite to that for removing.

For reference

The method for removing angle trim panels when the installation of trim panel is complete:

- Insert a straight screwdriver in the notch ①. Gently turn the screwdriver downward, and slowly insert it in, and then move it up and down to make the angle fall off.
- Make the angle ② and ③ fall off in the same way.
- Take off the angle trim panel by hand.

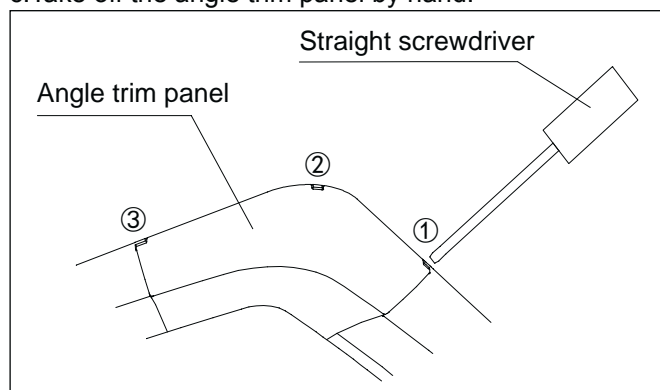

### Requirements:

- The drainpipe of the indoor unit should be heat-insulated.
- Heat insulation should be treated for the connection with the indoor unit. Improper heat insulation may cause condensing.
- The drainpipe with the down gradient of over 1/100 can't be in the S shape, or abnormal sound can be caused.
- The horizon length of the drainpipe should be kept with 20m. Under the condition of long pipes, supports can be provided every 1.5~2m as to avoid unevenness.
- The central piping should be connected according the following drawing.
- Take care not to apply external force on the connection of the drainpipes.

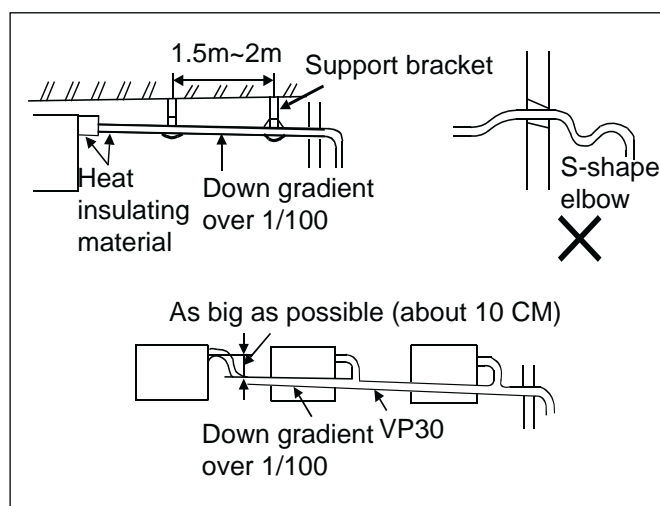

## Piping Materials & Heat Insulating Materials

As to prevent condensation, heat insulating treatment should be performed. The heat insulating treatment for piping should be done respectively.

Piping material	Hard PVC tube VP31.5mm (inner bore)
Heat insulating material	Vesicant polythene thickness: over 7mm

## Hose

The attached hoses can be used to adjust the eccentricity and angle of the hard PVC tube.

- Stretch the hose directly to make connections as to avoid distortion. The soft end of the hose should be positioned with a clamp.
- The hose should be used in the horizon direction.

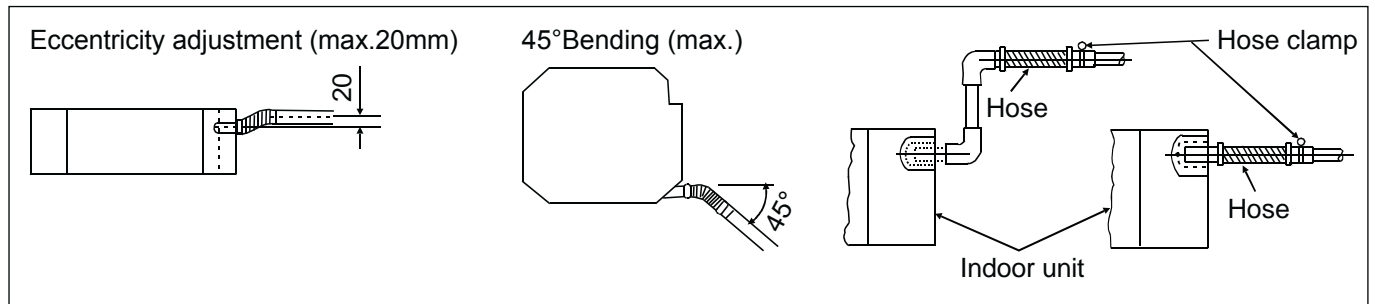

Heat Insulating Treatment:

- Wrap the connection between the clamp and the root segment of the indoor unit without any gap with heat insulating materials as shown in the drawing.

## Lifting Drainpipe

The drainpipe can be lifted 360mm. When the down gradient of the drainpipe can't be ensured, after upright lifting, the drainpipe is in the down slope.

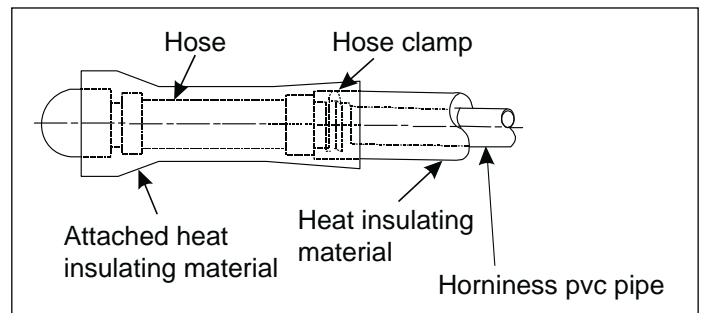

## Confirming Drainage

The drainage should be confirmed during the test run to make sure that there is leakage at the connection.

The confirmation of drainage should be also performed during the installation in the winter season.

Fill water from the outlet or the specified position and confirm the drainage. Fill 600cc water with a hose from the outlet or the specified location on the machine. Add the water slowly. Don't add water to the motor of the drainage pump.

- After mounting the electrical system, do cooling operation and meanwhile add water and check.
- If the electrical installation hasn't been completed, pull out the terminal (2P) of the floater switch on the electrical cabinet. After confirming the drainage, connect the terminal of the floater switch and run the drainage pump for 5 minutes until it stops automatically.
- Confirm the sound of the motor: Confirm the sound of the motor of the drainage pump and meanwhile check the drainage.

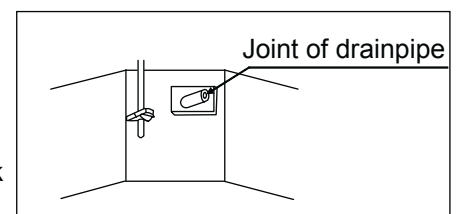
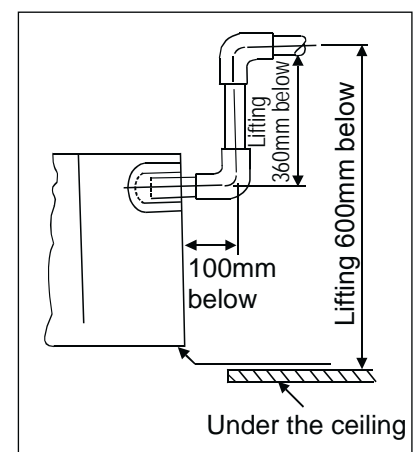

## Tubing Permissible Length & Height Difference

Please refer to the attached manual of outdoor units.

## Tubing Materials & Specifications

Please refer to the attached manual of outdoor units.

Model		AB072~092MRERA	AB122~182MRERA	AB242~602MRERA
Tubing size (mm)	Gas pipe	Ø9.52	Ø12.7	Ø15.88
	Liquid pipe	Ø6.35	Ø6.35	Ø9.52
Tubing material		Phosphor deoxy bronze seamless pipe (TP2) for air conditioner		

## Refrigerant Filling Amount

Add the refrigerant according to the installation instruction of outdoor unit. The addition of R410A refrigerant must be performed with a measure gage to ensure the specified amount while compressor failure can be caused by filling too much or little refrigerant.

## Connecting Procedures of Refrigerant Tubing

Proceed the flare tube connecting operation to connect all the refrigerant tubes.

- Dual wrenches must be used in the connection of indoor unit tubing.
- Mounting torque refers to the right table.

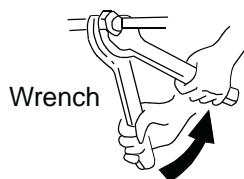

Outer Diameter of Tubing (mm)	Mounting Torque (N-m)	Increase mounting Torque (N-m)
Ø6.35	11.8 (1.2kgf-m)	13.7 (1.4kgf-m)
Ø9.52	24.5 (2.5kgf-m)	29.4 (3.0kgf-m)
Ø12.7	49.0 (5.0kgf-m)	53.9 (5.5kgf-m)
Ø15.88	78.4 (8.0kgf-m)	98.0 (10.0kgf-m)

## Cutting and Enlarging

Cutting or enlarging pipes should be proceeded by installation personnel according to the operating criterion if the tube is too long or flare opening is broken.

## Vacuumizing

Vacuumize from the stop valve of outdoor units with vacuum pump. Refrigerant sealed in indoor machine is not allowed to use for vacuumization.

## Open All Valves

Open all the valves of outdoor units. [NB: oil balancing stop valve must be shut up completely when connected one main unit.]

## Checkup for Air Leakage

Check if there is any leakage at the connecting part and bonnet with hydrophone or soapsuds.

## Connecting

### 1. Connecting circular terminals

The connecting method of circular terminal is shown in the Fig. Take off the screw, connect it to the terminal tier after heading it through the ring at the end of the lead and then tighten it.



### 2. Connecting straight terminals

The connection methods for the circular terminals are shown as follows: loosen the screw before putting the line terminal into the terminal tier, tighten the screw and confirm it has been clamped by pulling the line gently.

### 3. Pressing connecting line

After connecting line is completed, press the connecting line with clips which should press on the protective sleeve of the connecting line.

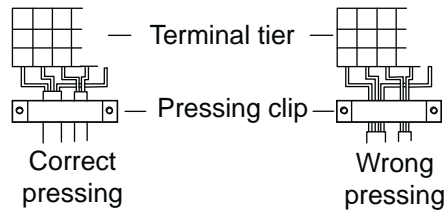

### 3.9.5 Electrical wiring

#### ⚠ WARNING

- Electrical construction should be made with specific mains circuit by the qualified personnel according to the installation instruction. Electric shock and fire may be caused if the capacity of power supply is not sufficient.
- During arranging the wiring layout, specified cables should be used as the mains line, which accords with the local regulations on wiring. Connecting and fastening should be performed reliably to avoid the external force of cables from transmitting to the terminals. Improper connection or fastness may lead to burning or fire accidents.
- There must be the ground connection according to the criterion. Unreliable grounding may cause electrical shocks. Do not connect the grounding line to the gas pipe, water pipe, lightning rod and telephone line.

#### ⚠ ATTENTION

- Only copper wire can be used. Breaker for electric leakage should be provided, or electric shock may occur.
- The wiring of the mains line is of Y type. The power plug L should be connected to the live wire and plug N connected to null wire while should be connected to the ground wire. For the type with auxiliary electrically heating function, the live wire and the null wire should not be misconnected, or the surface of electrical heating body will be electrified. If the power line is damaged, replace it by the professional personnel of the manufacturer or service center.
- The power line of indoor units should be arranged according to the installation instruction of indoor units.
- The electrical wiring should be out of contact with the high-temperature sections of tubing as to avoid melting the insulating layer of cables, which may cause accidents.
- After connected to the terminal tier, the tubing should be curved into be a U-type elbow and fastened with the pressing clip.
- Controller wiring and refrigerant tubing can be arranged and fixed together.
- The machine can't be powered on before electrical operation. Maintenance should be done while the power is shut down.
- Seal the thread hole with heat insulating materials to avoid condensation.
- Signal line and power line are separately independent, which can't share one line. [Note: the power line, signal line are provided by users. Parameters for power lines are shown as below:  $3 \times (1.0-1.5) \text{mm}^2$ ; parameters for signal line:  $2 \times (0.75-1.25) \text{mm}^2$  (shielded line)]
- 5 butt lines (1.5mm) are equipped in the machine before delivery, which are used in connection between the valve box and the electrical system of the machine. The detailed connection is displayed in the circuit diagram.

#### Supply Wiring Drawing

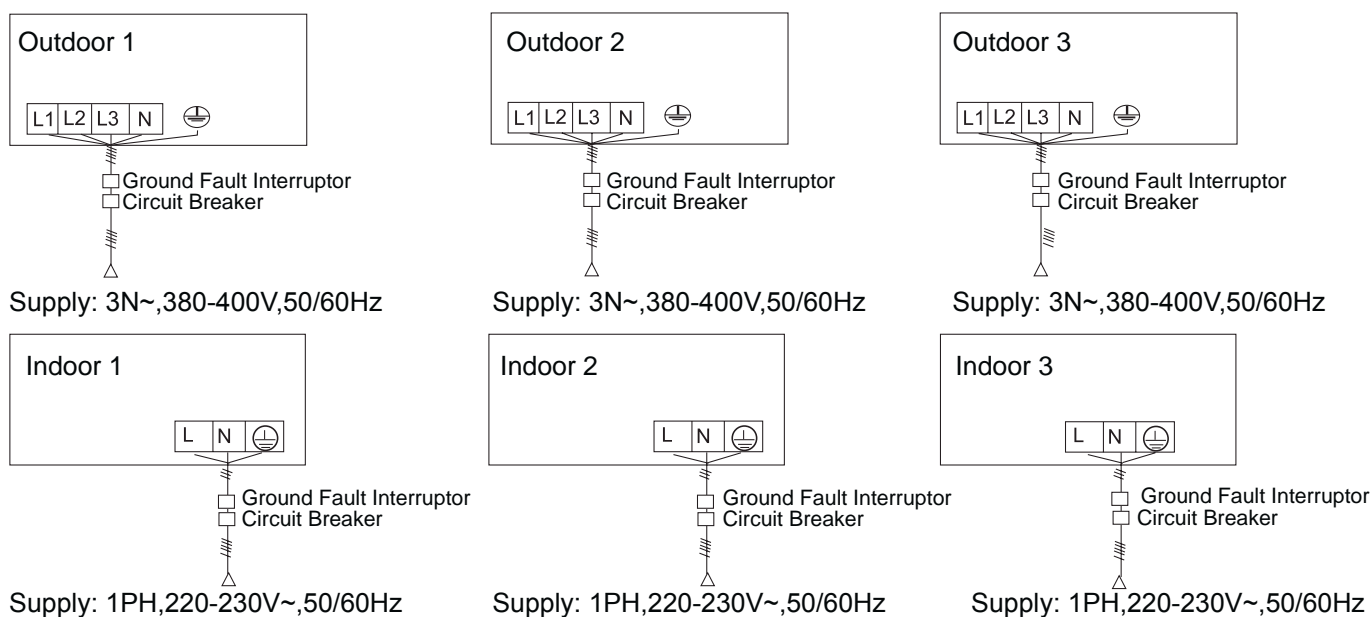

- Indoor units and outdoor units should be connected to the power source separately. Indoor units must share one single electrical source, but its capacity and specifications should be calculated. Indoor & outdoor units should be equipped with the power leakage breaker and the overflow breaker.



## Signal Wiring Drawing

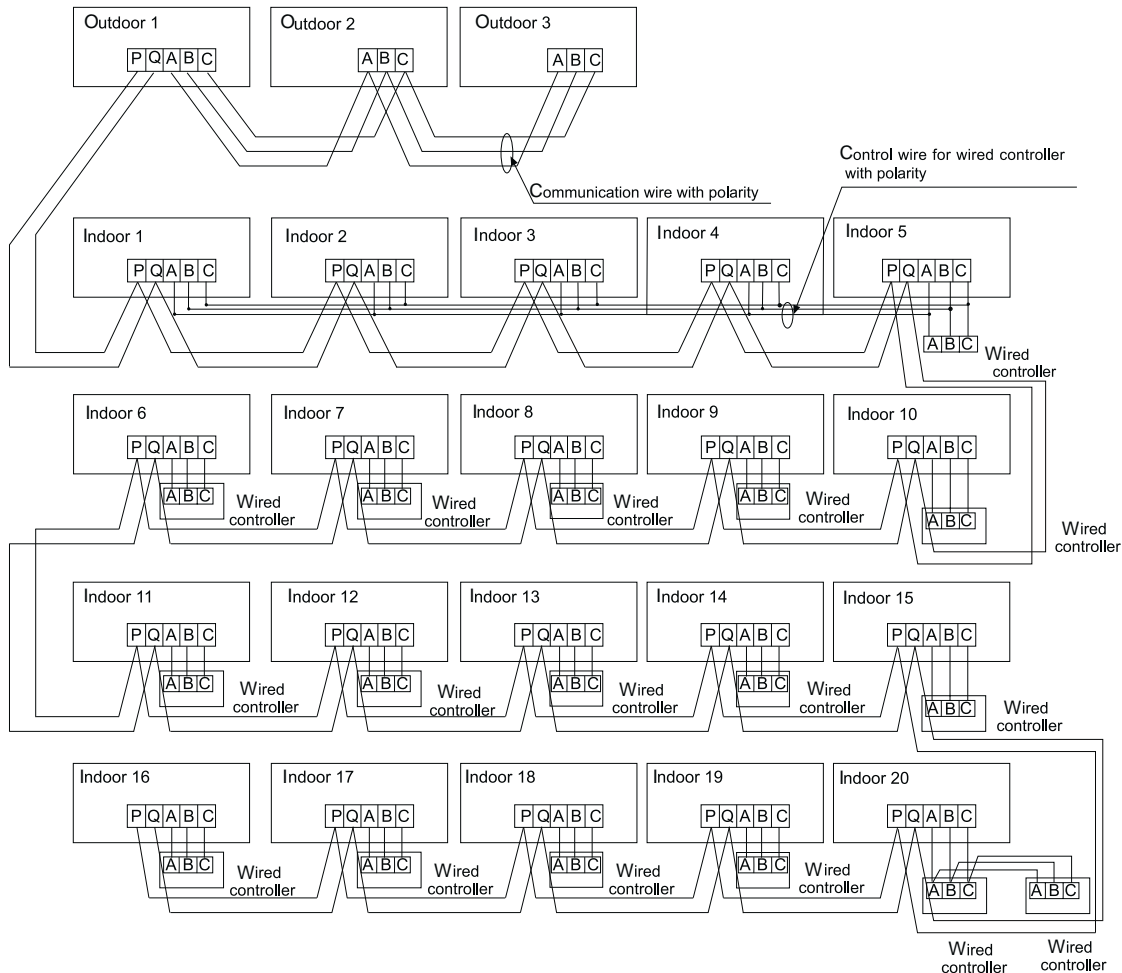

Outdoor units are of parallel connection via three lines with polarity. The master unit, central control and all indoor units are of parallel connection via two lines without polarity.

There are three connecting ways between wired controller and indoor units:

- A. One wired controller controls multiple units, i.e. 2-16 indoor units, as shown in the above figure (1-5 indoor units). The indoor unit 5 is the wired control master unit and others are the wired control slave units. The wired controller and the master unit (directly connected to the indoor unit of wired control) are connected via three lines with polarity. Other indoor units and the master unit are connected via three lines with polarity. SW01 on the wired control master unit is set to 0 while SW01 on other wired control slave units are set to 1, 2, 3 and so on in turn. (Please refer to the dip switch setting)
- B. One wired controller controls one indoor unit, as shown in the above figure (indoor unit 6-19). The indoor unit and the wired control are connected via three lines with polarity.
- C. Two wired controllers control one indoor unit, as shown in the figure (indoor unit 20). Either of the wired controls can be set to be the master wired controller while the other is set to be the slave wired controller. The master wired controller and indoor units and the master and slave wired controller are connected via three lines with polarity.

When the indoor units are controlled by the remote controller, refer to the "wired control master unit/ wired control slave unit/ remote control unit table". A, B, C on signal terminal block needn't wires to connect with the wired controller.

The wiring for the power line of indoor unit, the wiring between indoor and outdoor units as well as the wiring between indoor units:

Total current of indoor units (A)	Items	Cross section (mm <sup>2</sup> )	Length (m)	Rated current of overflow breaker (A)	Rated current of residual circuit breaker (A) Rated current of residual ground fault Interruptor (mA) response time (S)	Cross sectional area of signal Line	
						Outdoor-indoor (mm <sup>2</sup> )	Indoor-indoor (mm <sup>2</sup> )
<10		2	20	20	20 A,30 mA,0.1S or below	2 cores×(0.75-2.0)mm <sup>2</sup> shielded line	
≥10 and <15		3.5	25	30	30 A,30 mA,0.1S or below		
≥15 and <22		5.5	30	40	40 A,30 mA,0.1S or below		
≥22 and <27		10	40	50	50 A,30 mA,0.1S or below		

- The electrical power line and signal lines must be fastened tightly.
- Every indoor unit must have the ground connection.
- The power line should be enlarged if it exceeds the permissible length.
- Shielded lays of all the indoor and outdoor units should be connected together, with the shielded lay at the side of signal lines of outdoor units grounded at one point.
- It is not permissible if the whole length of signal line exceeds 1000m.

Signal wiring of wired controller

Length of signal line (m)	Wiring dimensions
≤ 250	0.75mm <sup>2</sup> ×3 core shielded line

- ※ The shielding lay of the signal line must be grounded at one end.
- ※ The total length of the signal line shall not be more than 250m.